

ELEGOO

Saturn 3 Ultra

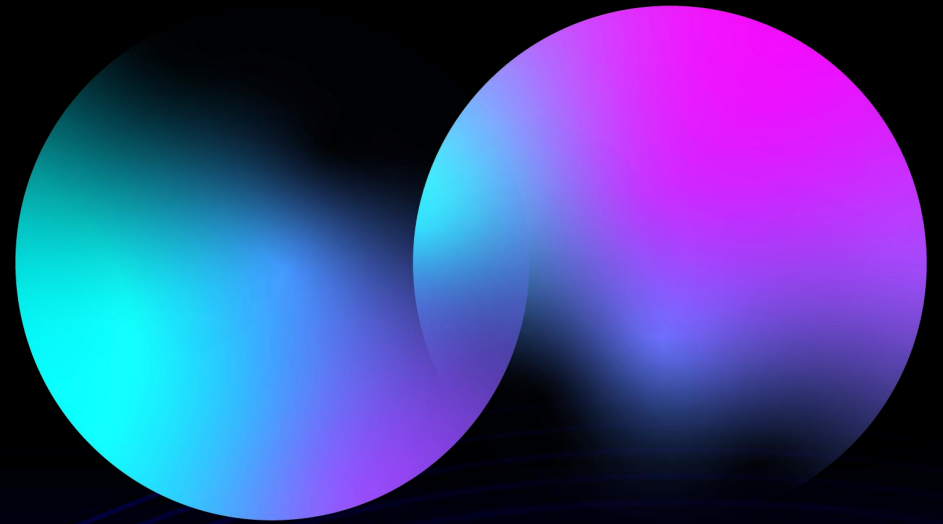

Metal Body • New Look

Saturn 3 Ultra 3D Printer

Resolution 11520*5120px

12K





12K

12K HD LCD Resolution
11520*5120(19*24um)

9H

Tempered Glass
9H Hardness



ACF Release Film
Fast Printing
3 times faster (max150mm/H)



WIFI Transfer

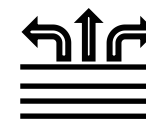

Upgraded
Heat Sink

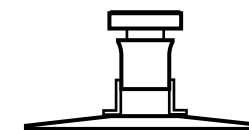

Laser Engraved
Build Plate

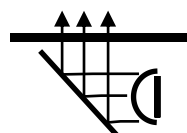

COB+Refractive
Light Source



HD Capacitive
Touch Screen

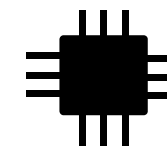

Linux System

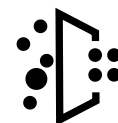

Upgraded Plug-in
Air Purifier



Multiple Languages



Open-Source GOO
Slicing Format
(support multiple slicing softwares)

Incredible 12K LCD Screen
XY Resolution 11520*5120px (19*24um)

12K ELEGOO



model by collectivestudio



model by loot.studios

Tempered Glass Screen Protector

9H hardness explosion-proof high-permeability
Wear-resistant and scratch-resistant
Effectively extend the life span of the LCD screen

Easy to clean
Protect the screen from leakage resin or other liquids
Prevent the screen from dirt and scratches

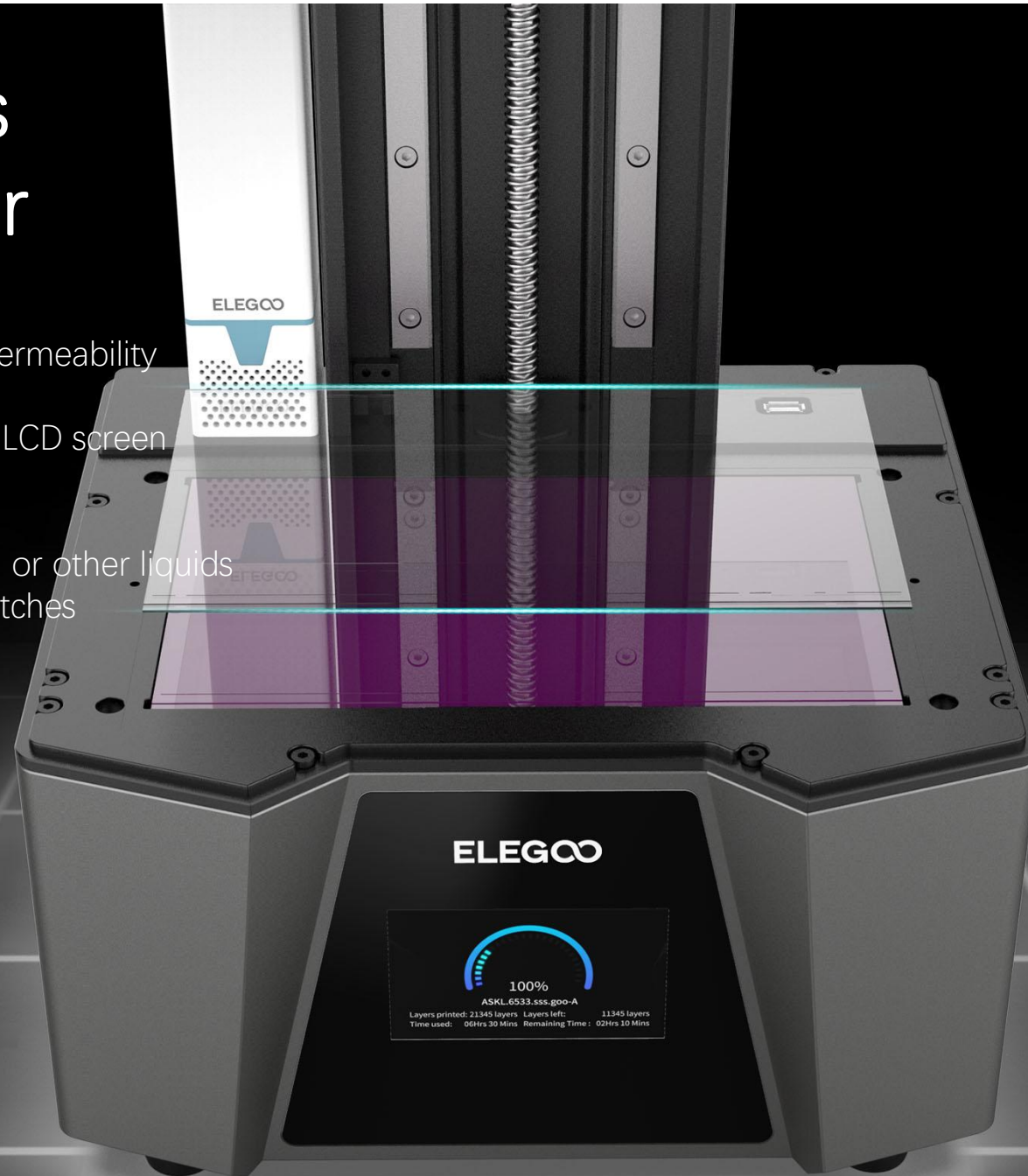

New Linux system

- Built-in 4G onboard memory, more stable file transfer
- Faster running, no delay in printing and loading pictures

ELEGOO



COB+Refractive Light Source

ELEGOO

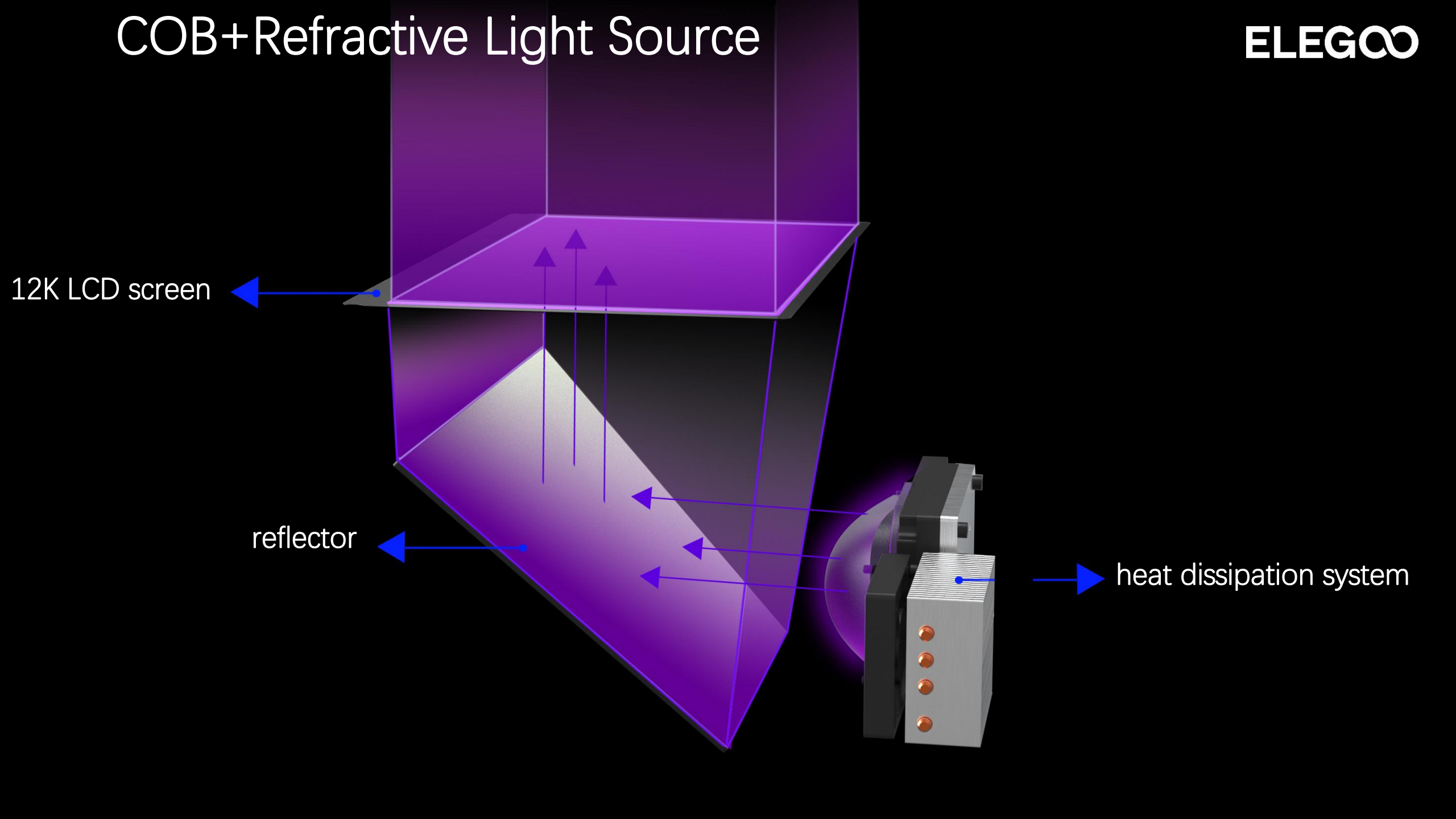

Support Wi-Fi Transfer

You can transfer files without plugging in the USB, the transfer speed is 6-10M/s*, compatible with 2.4G and 5G networks

ELEGOO

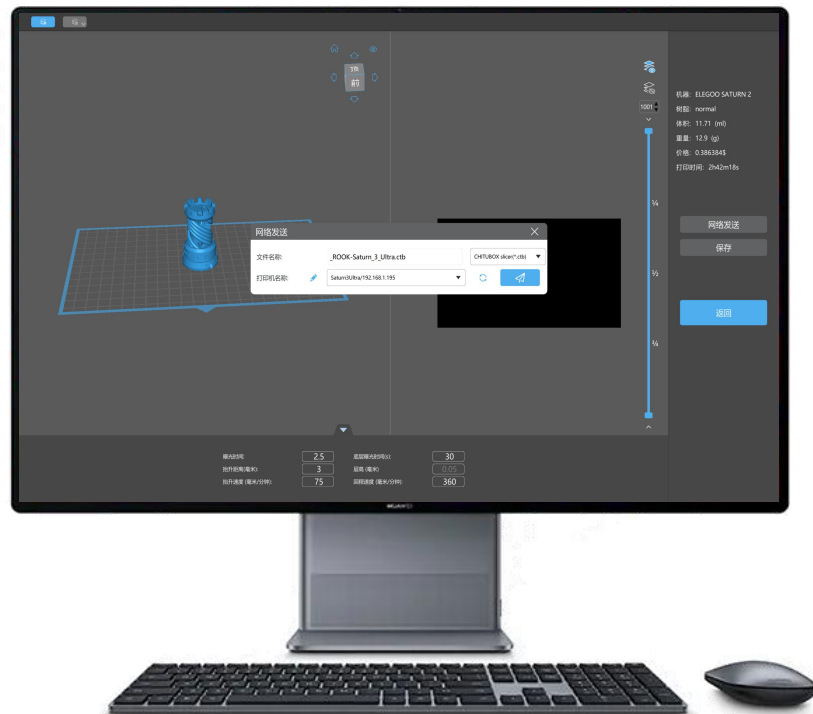

transfer via WIFI



*Above data from ELEGOO R&D Laboratory



Large Print Volume

218.88 (L)*122.88 (W)*260mm (H)
Satisfy your creativity

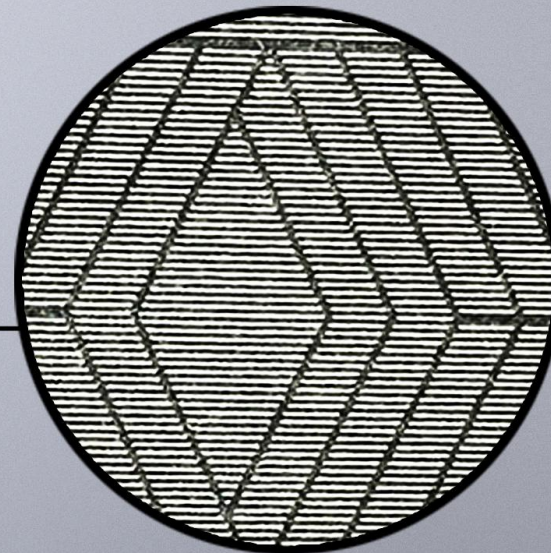
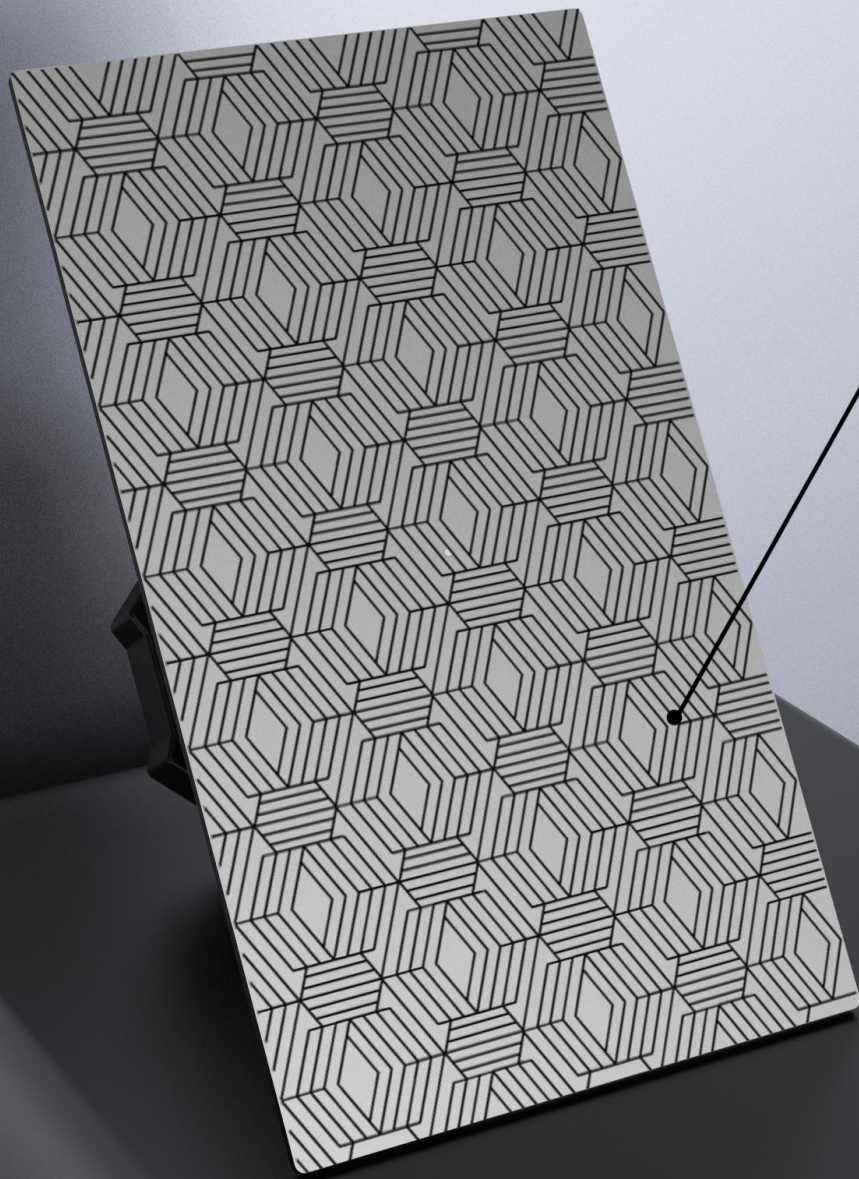

Laser Engraved Build Plate Enhance Model Adhesion

The build plate surface adopts laser engraving technology, providing ultra adhesion with the first layer of the model, to achieve a higher success rate in printing

Integrated Ball Screw Design + Double Z-Axis Linear Railways

ELEGOO

Faster motion, max 150mm/H
More stable, Z-axis precision 0.01mm
Significantly improve the print quality

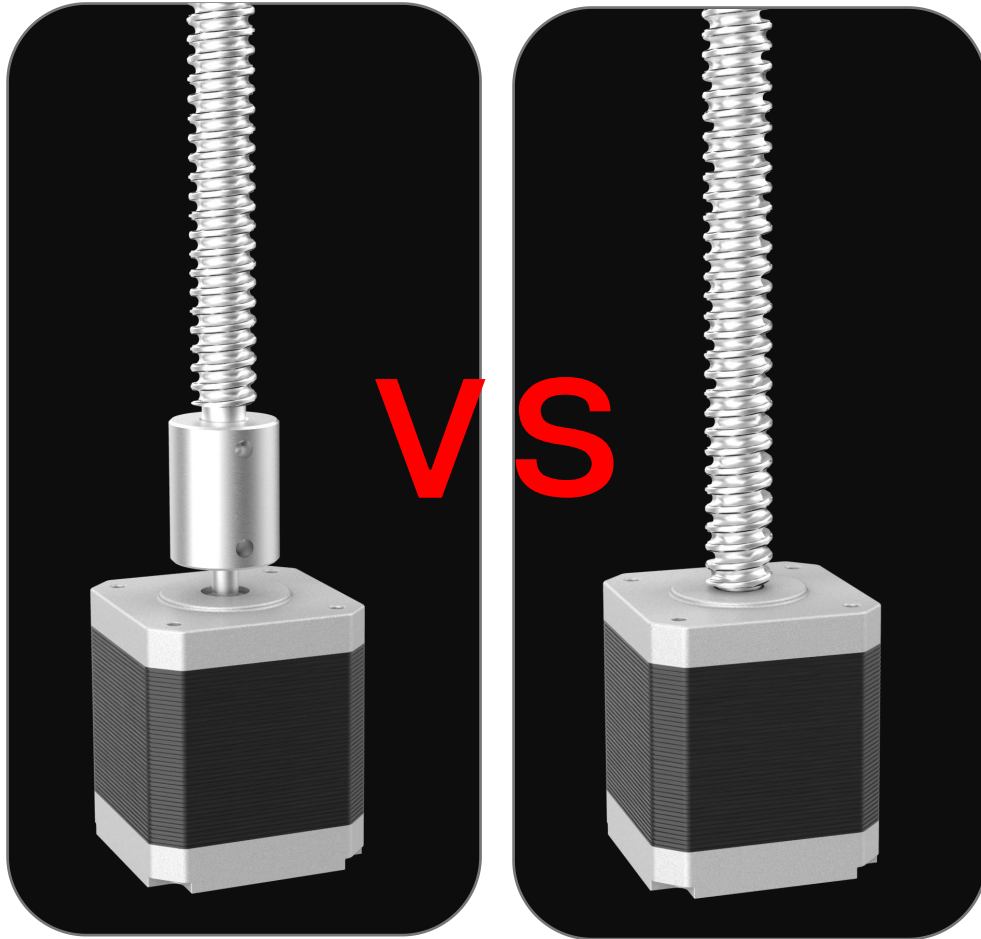

Screw from other brands

Integrated ball screw

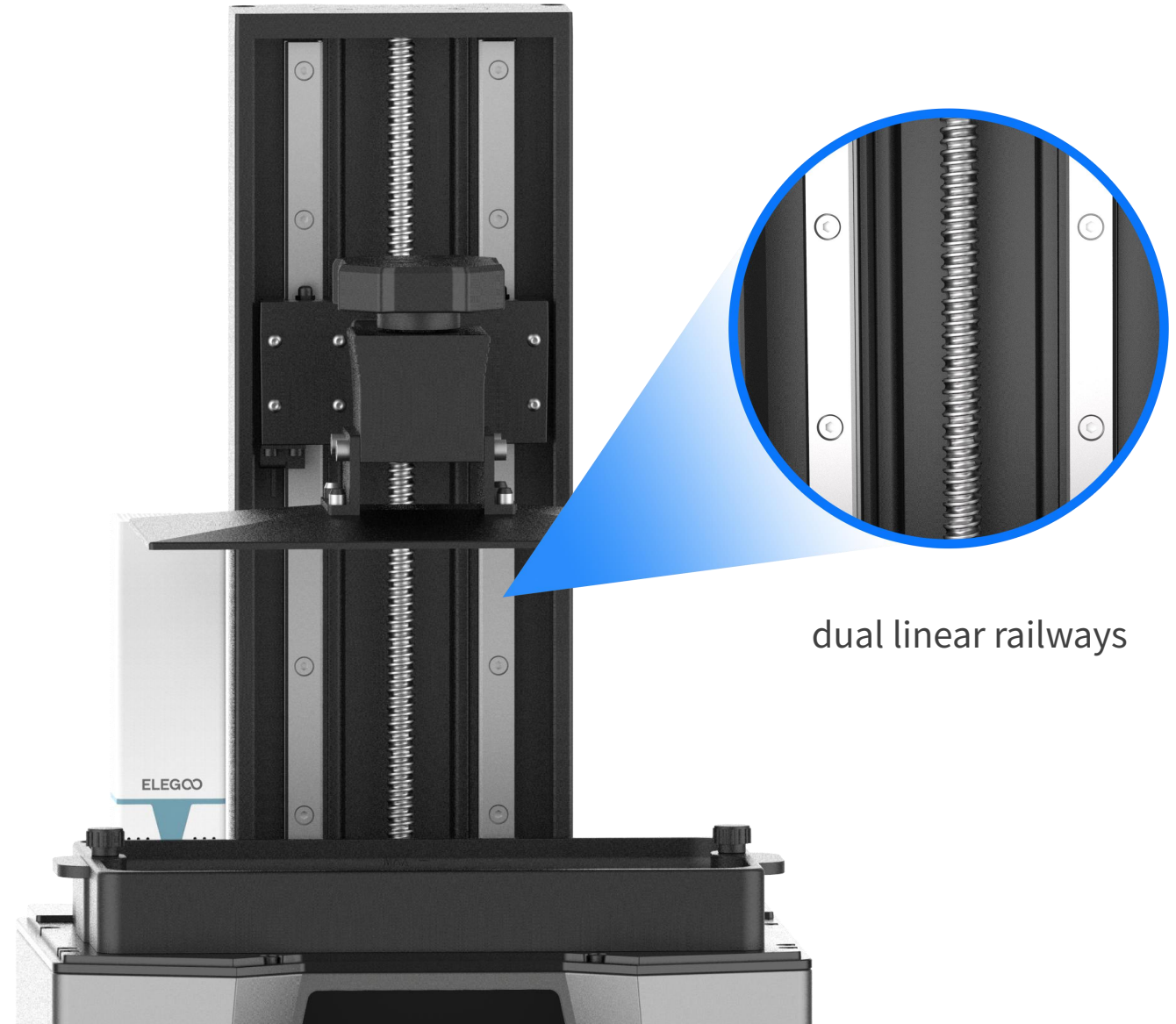

dual linear railways

4 Screws Leveling

Clockwise tightening,
easy operation,
only need leveling once*



Unique Heat Dissipation System

More efficient performance
Effectively prolonging the life span of the printer

ELEGOO

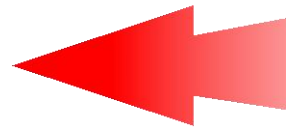
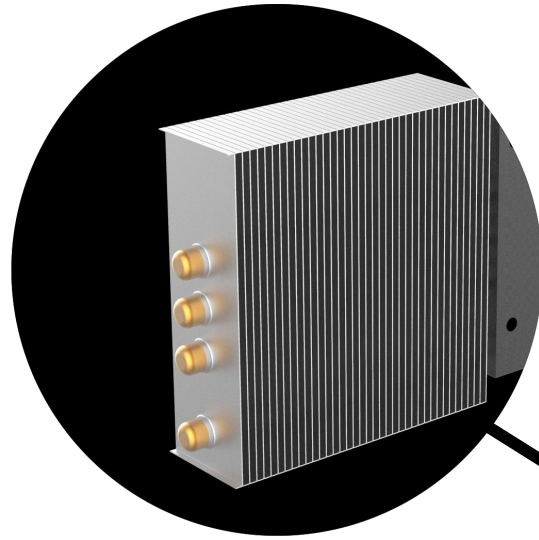

air out



air in

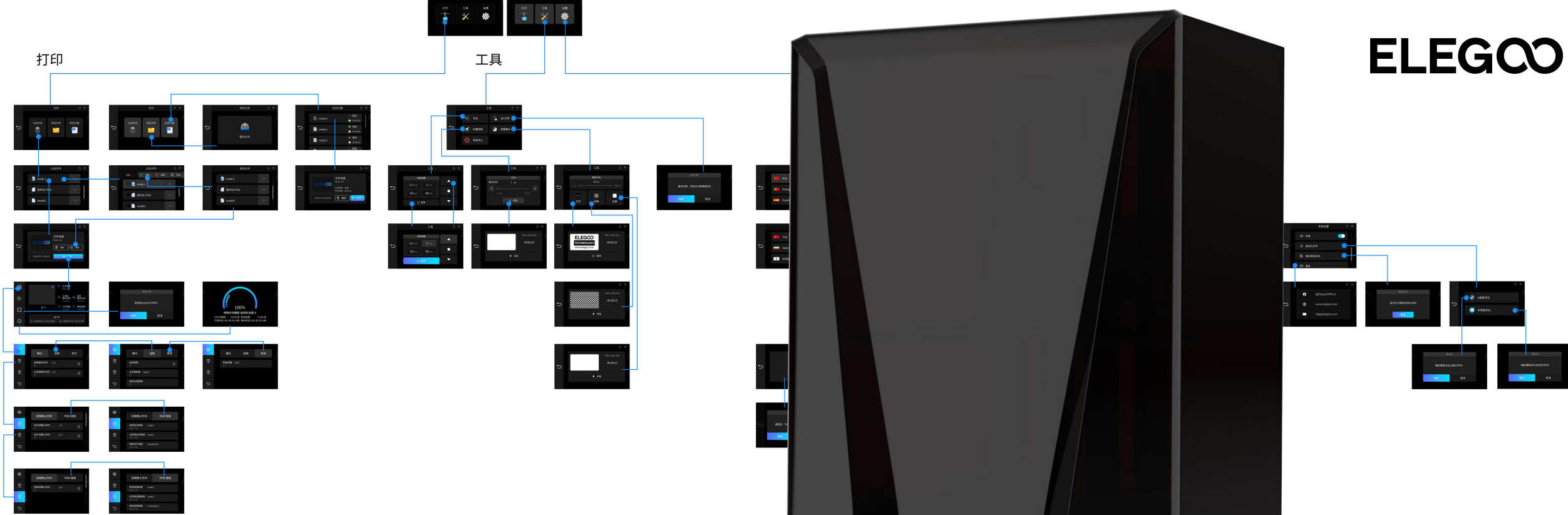

4-inch HD IPS Capacitive Touch Screen

- HD touch screen 800*480px
- New UI interface



12 Languages

ELEGOO

Chinese, English, Japanese, Korean, Portuguese, Russian, Turkish, German, Spanish, French, Dutch, Italian



Senseful Designs for better user experience

ELEGO

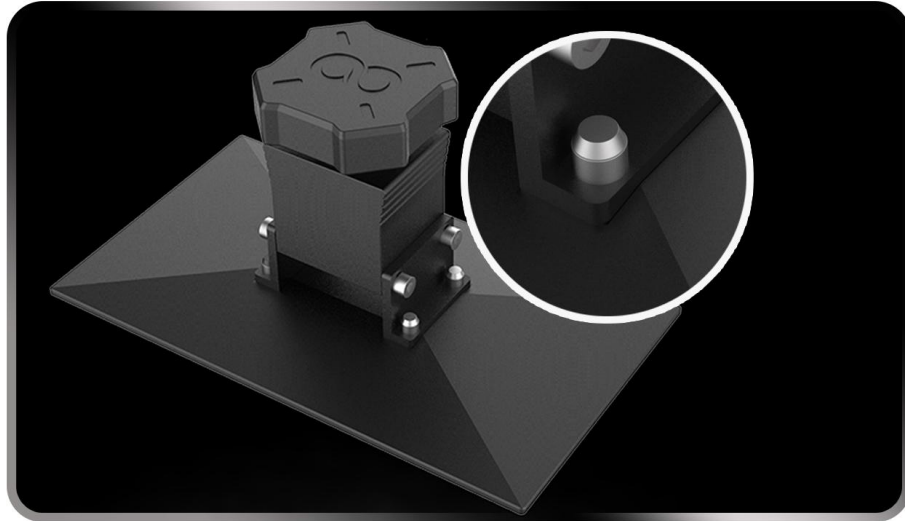

The 4 screws that fix the build plate are added a rubber cover on top to reduce the cleaning job

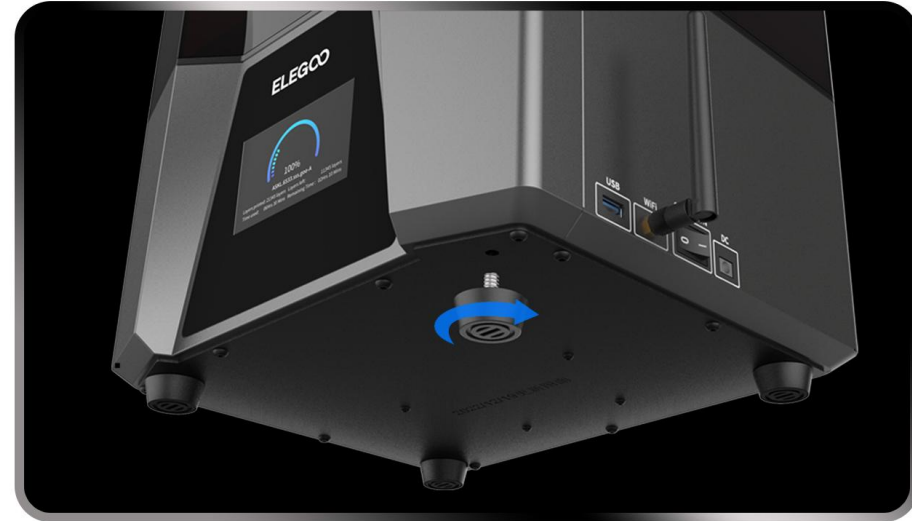

Adjustable foot pads, can adapt to the unevenness of the desktop where the machine is placed

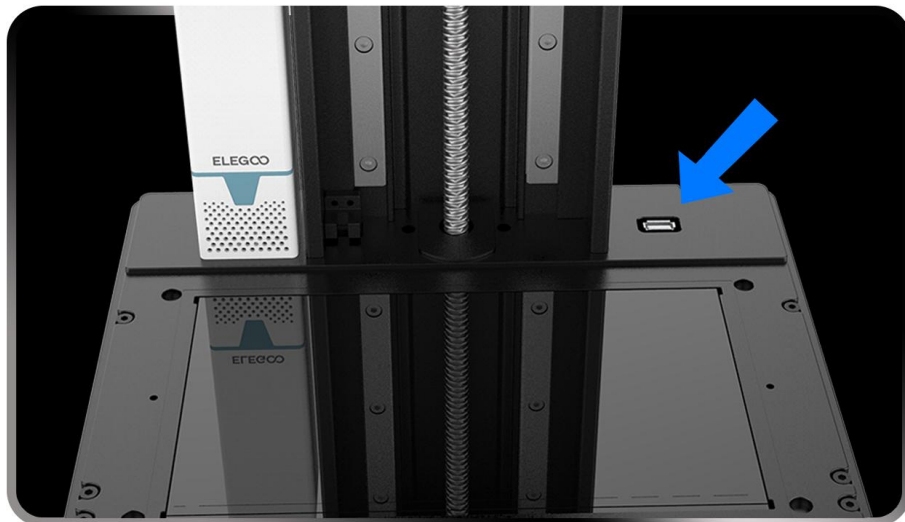

A USB interface is reserved to be able to use two air purifiers



The small stepped design of the middle platform effectively prevents the resin from flowing into the interior and damaging the machine

Compatible with the Big Boy - MARS MATE Air Purifier

SATURN 3 series 3D printer is perfectly compatible with this air purifier

Create an air-fresh 3D printing space



Upgraded Air Purifier 2.0

ELEGOO

Specially designed for 3D printers, it can effectively absorb the odor molecules emitted by the resin, purify the air. With a built-in cover for the activated carbon core, the filter element does not drop slag.



Upgraded filter core with a cover, effectively protect the activated carbon from damage during shipping

ACF Release Film + Resin Printing Speed Test

Better release, support fast printing, 3 times faster*

Saturn 3 Ultra

Standard resin / layer thickness 0.05mm
Print completion rate within the same time

60%

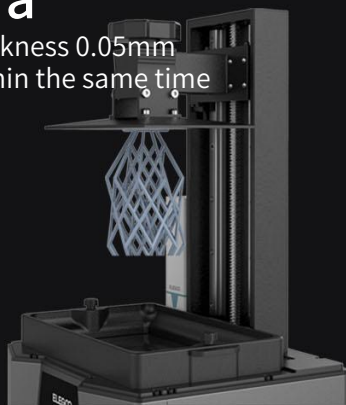

Saturn 3 Ultra

High-speed resin / layer thickness 0.15mm
Print completion rate within the same time

100%

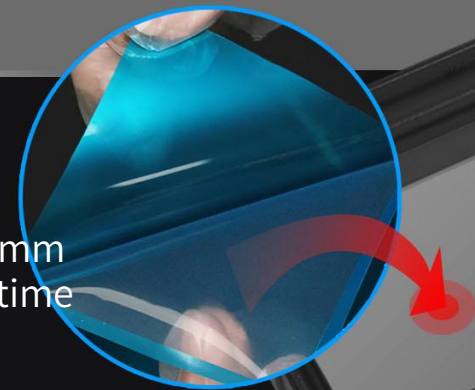
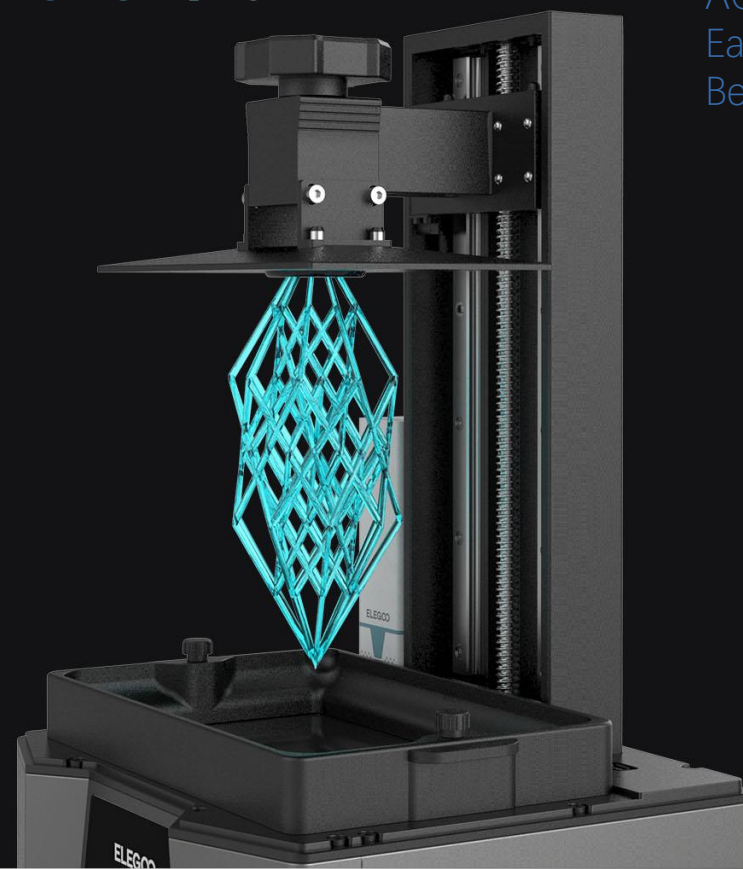

ACF film
Easier releasing
Better performance

SATURN 2

Standard resin / layer thickness 0.05mm
Print completion rate within the same time

30%

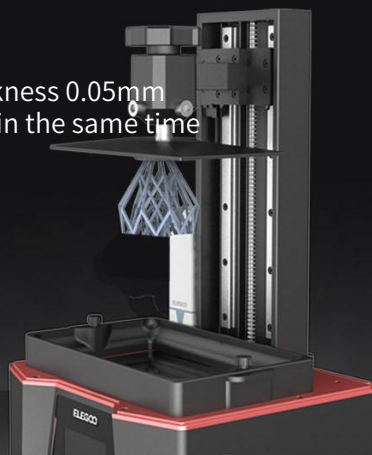

*The experimental results are provided by the ELEGOO R & D laboratory. The specific results should be subject to the actual operation and situation

Open-Source GOO Slice Format

ELEGOO

ELEGOO self-developed
Support multiple slicing softwares without restriction

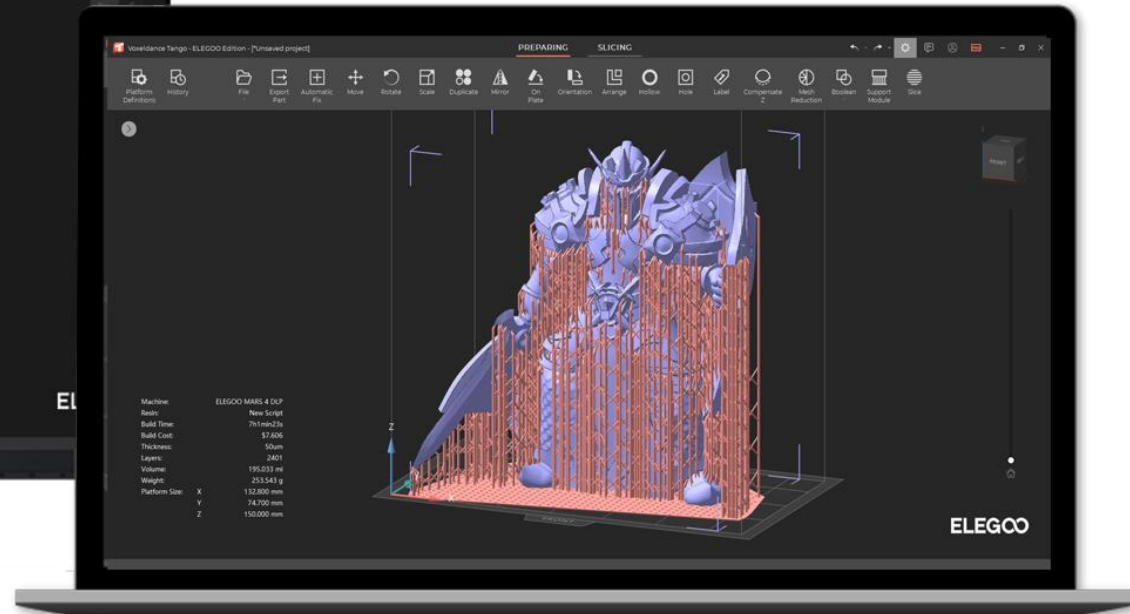
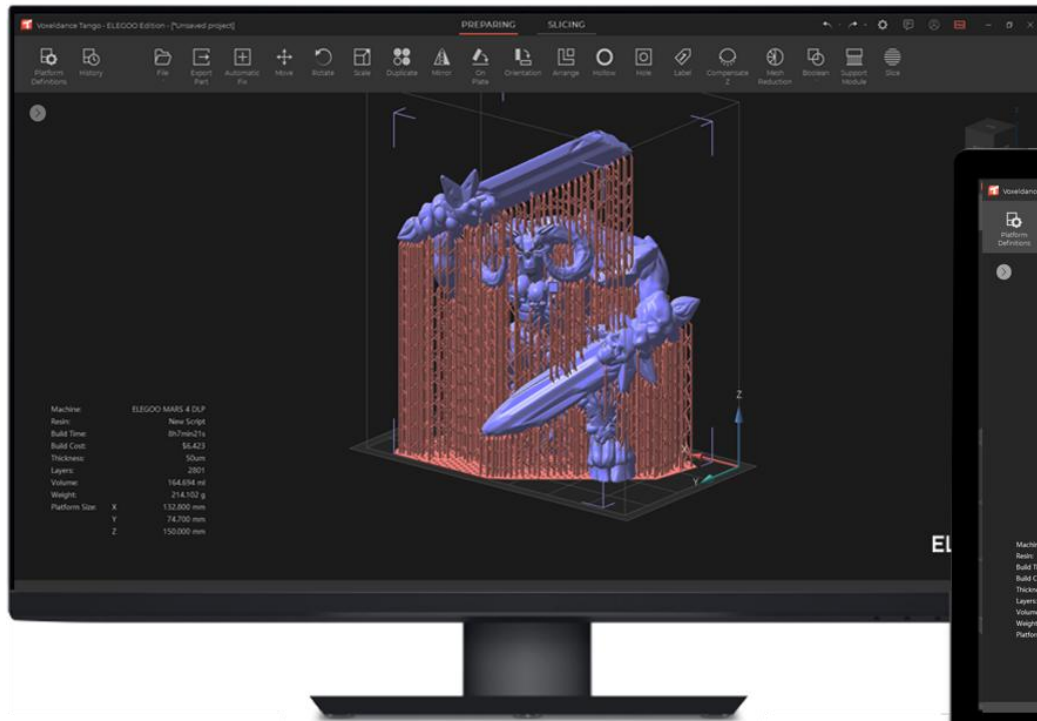

*Above data from ELEGOO R&D Laboratory

Saturn 3 Ultra Parameters

ELEGOO



System: EL3D-4.0

Control: 4.0 inch capacitive touch screen

Slicer: Chitu Box & Voxeldance Tango

Connectivity: USB & WiFi

Technology: MSLA

Lightsource: COB+refractive lightsource (wavelength 405nm)

XY Resolution: 19*24um (11520*5120)

Z Axis Accuracy: 0.01mm

Layer Thickness: 0.01-0.2mm

Printing Speed: MAX 150mm/H

Power Requirements: 100-240V 50/60 Hz 24V 7.5A

Printer Dimensions: 305.9mm(L)*273mm(W)*562.5mm(H)

Print Volume: 218.88mm (L)*122.88mm (W)*260mm (H)

Package Dimension: 640mm(L)*395mm(W)*365mm(H)

G.W.: 16.2KG

N.W.: 12KG

Wide Application



R&D



Dental



Education

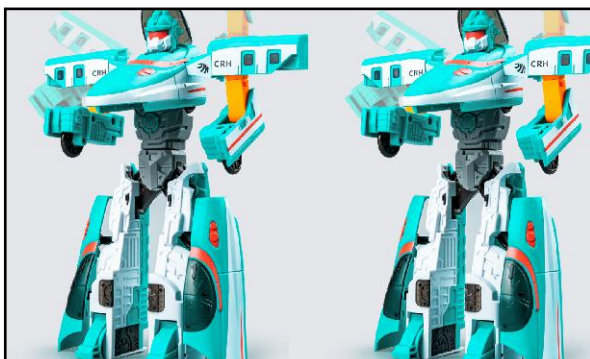

Miniatures



Jewelry

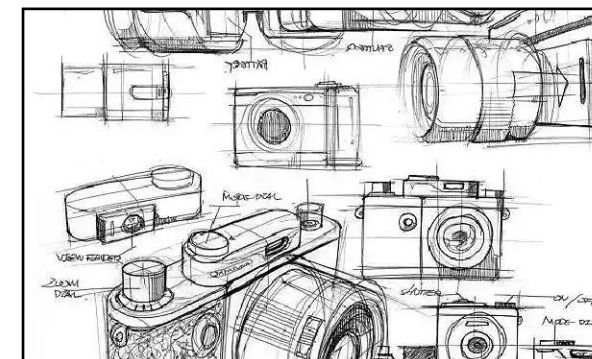

Design